

Part No:

HA18N5W-06



6 dB - Fixed Attenuator N Male To N Female Up To 18 GHz Rated To 5 Watts With Passivated Stainless Steel Body

The HASCO Fixed Attenuator **HA18N5W-06** is rated to 10 Watts and operates from DC to 18GHz. The versatile coaxial package uses N male to N female connectors.

The HA18N5W-06 is RoHS compliant.



RF microwave attenuators (also known as RF pads) lower the amplitude of a signal (attenuate) a known amount and can be used in a wide variety of applications. These attenuator pads are used when a signal needs to be reduced to protect measurement equipment or other circuitry, to extend the range of power meters and amplifiers, and to impedance match circuits by reducing the VSWR seen by adjacent components. RF attenuators can prevent signal overload in amplifiers, receivers and detectors, adjusting the signal level to a range that is optimal.

Electrical

- Frequency Range DC - 18 GHz
- VSWR (MAX) DC - 4 GHz..... 1.15:1
4 - 12.4 GHz..... 1.25:1
12.4 - 18 GHz..... 1.35:1
- Impedance 50 Ohms
- Power 5 Watts Average
Derates linearly from +25° to 10% at +125°
- Power Peak 500 Watts - 5 µSec Pulse Width 0.25% Duty Cycle

Environmental Data

- Temperature Range -65°C - +125°C

Material

- Outer Conductor: Passivated Stainless Steel
- Housing Aluminum, Black Anodize Finish
- Center Conductor: BeCu, Gold Plated
- Resistor Substrate: AlN or Aluma Ceramic.
- Resistor: Proprietary Thin Film Hybrid with Protective Coating
- Dielectric: Teflon per ASTM D1710

**dB Value	PART NO.	MAX Dev.
1	HA18N5W-01	± 0.30
2	HA18N5W-02	± 0.30
3	HA18N5W-03	± 0.30
4	HA18N5W-04	± 0.30
5	HA18N5W-05	± 0.30
6	HA18N5W-06	± 0.30
7	HA18N5W-07	± 0.50
8	HA18N5W-08	± 0.50
9	HA18N5W-09	± 0.50
10	HA18N5W-10	± 0.50
11	HA18N5W-11	± 0.50
12	HA18N5W-12	± 0.50
15	HA18N5W-15	± 0.50
20	HA18N5W-20	± 0.50
30	HA18N5W-30	± 0.75
40	HA18N5W-40	± 1.25

To view online, go to: <https://www.hasco-inc.com/attenuators/6-db-fixed-attenuator-n-male-to-n-female-up-to-3-ghz-rated-to-5-watts-with-black-aluminum-heatsink-body/>

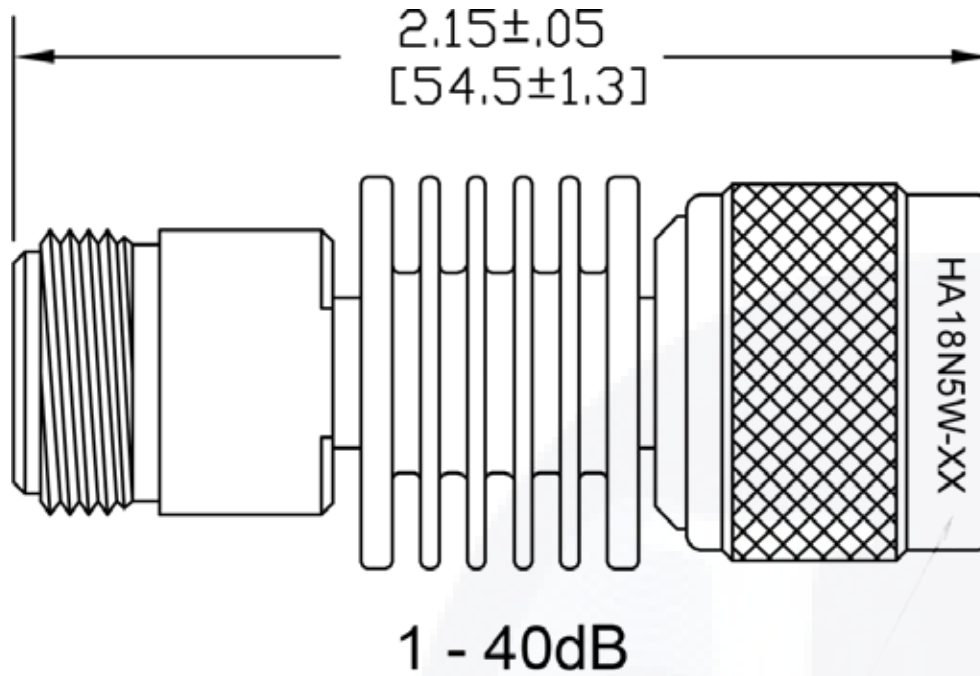

To view online, go to: <https://www.hasco-inc.com/attenuators/6-db-fixed-attenuator-n-male-to-n-female-up-to-3-ghz-rated-to-5-watts-with-black-aluminum-heatsink-body/>

LTR	DESCRIPTION	DATE	APPR.	DRAWN BY: ABC	CHECKED BY: ABC	 5214 Bonsai Street • Moorpark, CA 93021 (888) 498-3242 • sales@hasco-inc.com www.hasco-inc.com
-	RELEASE	5/16	TAC	APPROVED BY: ABC		
				THESE DRAWINGS AND SPECIFICATIONS ARE THE PROPERTY OF HASCO COMPONENTS AND SHALL NOT BE REPRODUCED, COPIED NOR USED - IN WHOLE OR IN PART - AS THE BASIS FOR THE MANUFACTURE OR SALE OF OTHER ITEMS WITHOUT THE EXPRESS, WRITTEN PERMISSION OF HASCO COMPONENTS.		
				MATERIALS: SEE DATA SHEET	CAGE CODE: 0T8L4	SCALE: N/A
				FINISHES: SEE DATA SHEET	PART NO./DRAWING NO. HA18N5W-06	
						SIZE: A
						REV: -
THIS DRAWING IS A CONTROLLED DOCUMENT						