

Part No:

HA26A-20



HASCO, INC
COMPONENTS DISTRIBUTOR



*20 dB - Fixed Attenuator SMA Male To SMA Female Up To 26 GHz
Rated To 2 Watts with Passivated Stainless Steel Body*

Electrical

- Frequency Range DC - 26 GHz
- VSWR
 - DC - 6 GHz 1.15:1
 - 6 - 18 GHz 1.25:1
 - 18 - 26 GHz..... 1.35:1
- Impedance 50 Ohms
- Power 2 Watt @ 25°C
Derates Linearly to .5W @125°C
- Power Peak 500 Watts
5µSec PW 0.10% Duty Cycle

**dB Value	PART NO.	ATTENUATION
1	HA26A-01	± 0.50
2	HA26A-02	± 0.50
3	HA26A-03	± 0.50
4	HA26A-04	± 0.50
5	HA26A-05	± 0.50
6	HA26A-06	± 0.50
7	HA26A-07	± 0.50
8	HA26A-08	± 0.50
9	HA26A-09	± 0.50
10	HA26A-10	± 0.50
11	HA26A-11	± 0.50
12	HA26A-12	± 0.50
15	HA26A-15	± 0.75
20	HA26A-20	± 0.75
30	HA26A-30	± 1.25

Environmental Data

- Temperature Range -65°C - +125°C

Material

- Outer Conductors Passivated Stainless Steel
- Center Conductor Gold Plated BeCu
- Dielectric Teflon

The HASCO Fixed Attenuator **HA26A-20** is rated to 2 Watts and operates from DC to 26 GHz. The versatile coaxial package uses SMA male to SMA female connectors.

The HA26A-20 is RoHS compliant.



RF microwave attenuators (also known as RF pads) lower the amplitude of a signal (attenuate) a known amount and can be used in a wide variety of applications. These attenuator pads are used when a signal needs to be reduced to protect measurement equipment or other circuitry, to extend the range of power meters and amplifiers, and to impedance match circuits by reducing the VSWR seen by adjacent components. RF attenuators can prevent signal overload in amplifiers, receivers and detectors, adjusting the signal level to a range that is optimal.

To view online, go to: <https://www.hasco-inc.com/attenuators/ha26a-20-sma-male-to-female-attenuator-dc-26ghz-20db-with-hex-nut/>

HA26A-20 | DC - 26 GHz • 2 Watts | Outline Drawing

**dB Value	PART NO.	ATTENUATION
1	HA26A-01	± 0.50
2	HA26A-02	± 0.50
3	HA26A-03	± 0.50
4	HA26A-04	± 0.50
5	HA26A-05	± 0.50
6	HA26A-06	± 0.50
7	HA26A-07	± 0.50
8	HA26A-08	± 0.50
9	HA26A-09	± 0.50
10	HA26A-10	± 0.50
11	HA26A-11	± 0.50
12	HA26A-12	± 0.50
15	HA26A-15	± 0.75
20	HA26A-20	± 0.75
30	HA26A-30	± 1.25

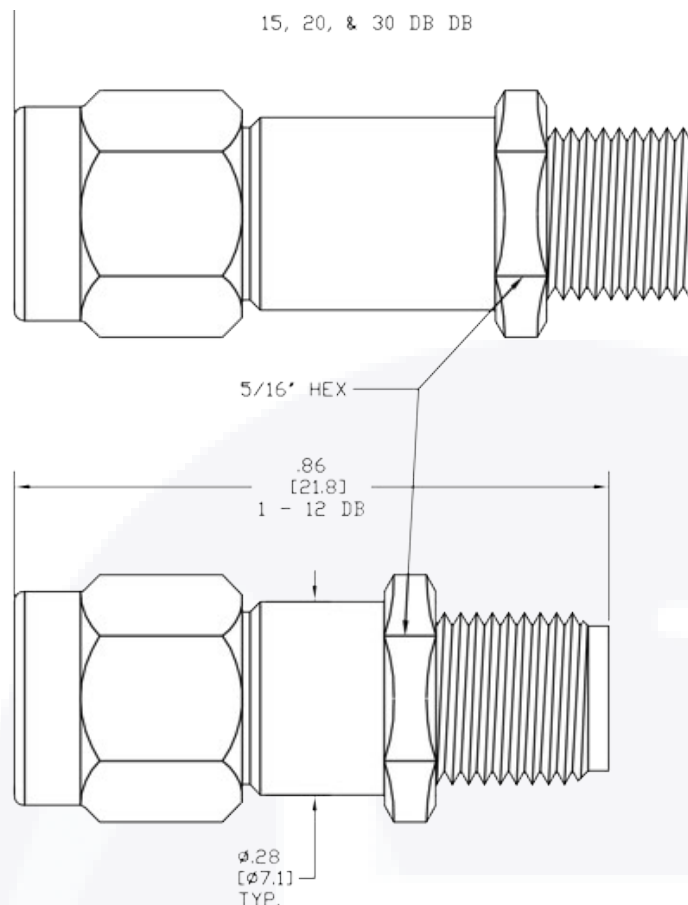

To view online, go to: <https://www.hasco-inc.com/attenuators/ha26a-20-sma-male-to-female-attenuator-dc-26ghz-20db-with-hex-nut/>

LTR	DESCRIPTION	DATE	APPR.	DRAWN BY: ABC	CHECKED BY: ABC		5214 Bonsai Street • Moorpark, CA 93021 (888) 498-3242 • sales@hasco-inc.com www.hasco-inc.com			
-	RELEASE	12/16	TAC	APPROVED BY: ABC						
				THESE DRAWINGS AND SPECIFICATIONS ARE THE PROPERTY OF HASCO COMPONENTS AND SHALL NOT BE REPRODUCED, COPIED NOR USED - IN WHOLE OR IN PART - AS THE BASIS FOR THE MANUFACTURE OR SALE OF OTHER ITEMS WITHOUT THE EXPRESS, WRITTEN PERMISSION OF HASCO COMPONENTS.			MATERIALS:	CAGE CODE:	SCALE:	SIZE:
							SEE DATA SHEET	OT8L4	N/A	A
							FINISHES:	PART NO./DRAWING NO.		REV:
							SEE DATA SHEET	HA26A-20		-
THIS DRAWING IS A CONTROLLED DOCUMENT										