

Part No:

HA65A-09



9 dB - Fixed Attenuator 1.85mm Male To 1.85mm Female Up To 65 GHz Rated To 1 Watt With Passivated Stainless Steel Body

The HASCO Fixed Attenuator **HA65A-09** is rated to 1 Watts and operates from DC to 65GHz. The versatile coaxial package uses 1.85mm male to 1.85mm female connectors.

The HA65A-09 is RoHS compliant.



RF microwave attenuators (also known as RF pads) lower the amplitude of a signal (attenuate) a known amount and can be used in a wide variety of applications. These attenuator pads are used when a signal needs to be reduced to protect measurement equipment or other circuitry, to extend the range of power meters and amplifiers, and to impedance match circuits by reducing the VSWR seen by adjacent components. RF attenuators can prevent signal overload in amplifiers, receivers and detectors, adjusting the signal level to a range that is optimal.

Electrical

• Frequency Range	DC - 65 GHz			
• Attenuation Accuracy	<u>DC-26.5 GHz</u>	<u>26.5-40 GHz</u>	<u>40-50 GHz</u>	<u>50-65 GHz</u>
1-9 dB	± 0.75 dB	± 1.00 dB	±1.50 dB	±1.50 dB
10 dB	± 0.75 dB	± 1.25 dB	±1.50 dB	±1.75 dB
20 dB	±1.00 dB	±1.25 dB	±2.00 dB	±2.50 dB
30 dB	±1.25 dB	±1.50 dB	±2.00 dB	±5.50 dB
• VSWR	1.35:1	1.55:1	1.55:1	1.65:1
• Impedence	50 Ohms			
• Power	1 Watt Average Derates linearly to 10% @ 100°C from +25°C			

Environmental Data

• Temperature Range	-55°C - +100°C
---------------------	----------------

Material

• Dielectric	High Temperature Plastic Bead
• Contact	Beryllium Copper
• Housing	Passivated Stainless Steel IAW ASTM-A484 & ASTM-A582, Alloy 303 Cond A
• Conductor	Gold Plated IAW MIL-PRF-39012

To view online, go to: <https://www.hasco-inc.com/attenuators/9-db-fixed-attenuator-1-85mm-male-to-1-85mm-female-up-to-65-ghz-rated-to-1-watt-with-passivated-stainless-steel-body/>

HA65A-09 | DC - 65 GHz • 1 Watt | Outline Drawing

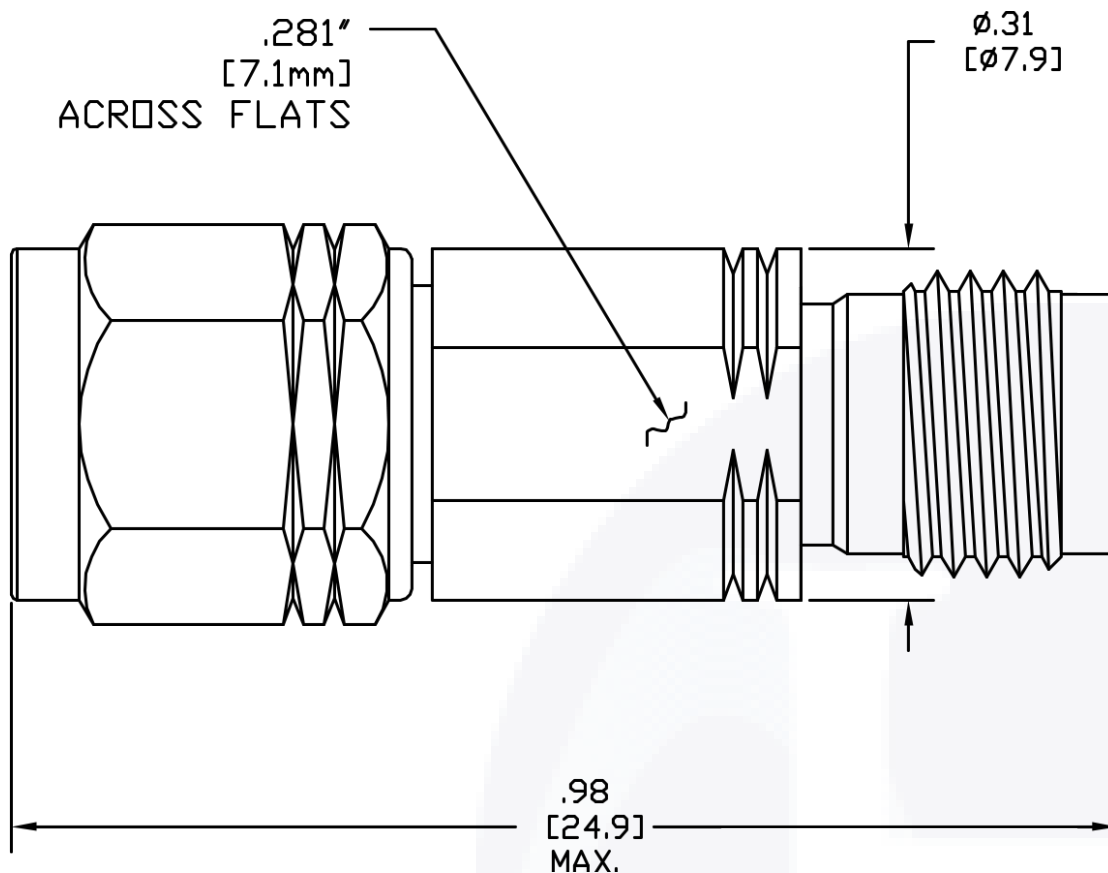

To view online, go to: <https://www.hasco-inc.com/attenuators/9-db-fixed-attenuator-1-85mm-male-to-1-85mm-female-up-to-65-ghz-rated-to-1-watt-with-passivated-stainless-steel-body/>

LTR	DESCRIPTION	DATE	APPR.	DRAWN BY: <i>D. SAUNDERS</i>	CHECKED BY: <i>TAC</i>	 <p>5214 Bonsai Street • Moorpark, CA 93021 (888) 498-3242 • sales@hasco-inc.com www.hasco-inc.com</p>
-	RELEASE	12/16	TAC	APPROVED BY: <i>T. KUHN</i>		
				THESE DRAWINGS AND SPECIFICATIONS ARE THE PROPERTY OF HASCO COMPONENTS AND SHALL NOT BE REPRODUCED, COPIED NOR USED - IN WHOLE OR IN PART - AS THE BASIS FOR THE MANUFACTURE OR SALE OF OTHER ITEMS WITHOUT THE EXPRESS, WRITTEN PERMISSION OF HASCO COMPONENTS.		MATERIALS: SEE DATA SHEET
						CAGE CODE: 0T8L4
						SCALE: N/S
						SIZE: A
						FINISHES: SEE DATA SHEET
						PART NO./DRAWING NO. HA65A-09
						REV: -
THIS DRAWING IS A CONTROLLED DOCUMENT						