

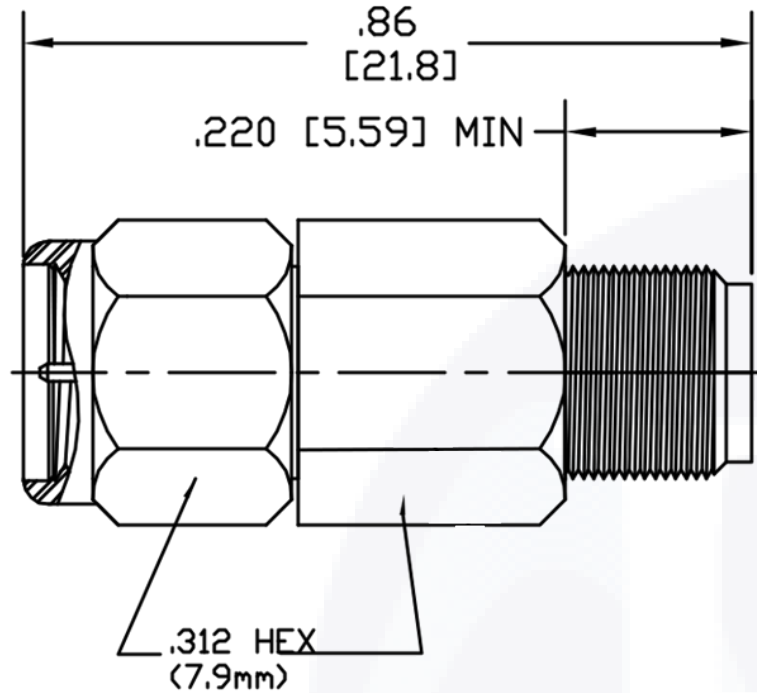

HA6A-02 | DC - 6 GHz • 2 Watts | Outline Drawing



LTR	DESCRIPTION	DATE	APPR.	DRAWN BY:	CHECKED BY: TAC		5214 Bonsai Street • Moorpark, CA 93021 (888) 498-3242 • sales@hasco-inc.com www.hasco-inc.com		
-	RELEASE	12/16	TAC	APPROVED BY: TAC					
				THESE DRAWINGS AND SPECIFICATIONS ARE THE PROPERTY OF HASCO COMPONENTS AND SHALL NOT BE REPRODUCED, COPIED NOR USED - IN WHOLE OR IN PART - AS THE BASIS FOR THE MANUFACTURE OR SALE OF OTHER ITEMS WITHOUT THE EXPRESS, WRITTEN PERMISSION OF HASCO COMPONENTS.		MATERIALS:	CAGE CODE:	SCALE:	SIZE:
						SEE DATA SHEET	OT8L4	NS	-
						FINISHES:	PART NO./DRAWING NO.		REV:
						SEE DATA SHEET	HA6A-02		-
THIS DRAWING IS A CONTROLLED DOCUMENT									