

Part No:

HLL283R-S1-S1-36



SMA Male to SMA Male Test Cable using LL283 Low Loss Ruggedized Flexible Cable, Excellent Phase and Amplitude Stability vs. Flexure, DC- 26.5 GHz, 36 Inches



The HASCO **HLL283R Series Cable** is a low loss LL283 cable that operates from DC to 26.5 GHz. This cable series is constructed with SMA Male to SMA Male connectors. These cables are internally ruggedized with multi-layer copper spiral and braided armor. They offer excellent phase and amplitude stability vs. flexure. The HLL283R Series cables offer 1.30:1 max VSWR.

The HLL283R-S1-S1-36 is RoHS Compliant.



HASCO offers many types and configurations of RF and microwave cable assemblies and can support most requirements, such as flexible, conformable, semi-rigid, VGA, low-loss, phase stable, armored, jacketed and more; all assembled with the highest quality RF connectors.

Specifications

• Frequency Range	DC - 26.5 GHz
• Insulation Resistance	5,000M Ω
• Insertion Loss	\leq 1.9dB @ 26.5 GHz
• VSWR	1.30:1 MAX
• Impedance	50 Ohms
• Dielectric Withstanding Voltage	1,000V Max at Sea Level
• Min. Bend Radius	1.8" (dynamic) - .7" (static)
• Velocity of Propagation	76%
• RF Leakage	$>$ 90 dB
• Phase Stability	$\leq \pm$ 0.03dB @ 26.5 GHz
• Phase Stability over Flexure	$\leq \pm$ 2.7° @ 26.5 GHz
• Dielectric Withstanding Voltage	1,000V Max at Sea Level
• Capacitance	27pf/ft=88pf/m
• Temperature Range	-55°C - +125°C

Materials and Finishes

DESCRIPTION

- Connectors
- Insulation
- Inner and Outer Shield
- Inner Armor
- Jacket
- Outer Armor

MATERIALS

- Stainless Steel
- PTFE
- Copper
- Copper
- FEP
- PTFE Braid

FINISH OR COLOR

- Passivated
- N/A
- Silver Plated
- Silver Plated
- N/A
- Purple

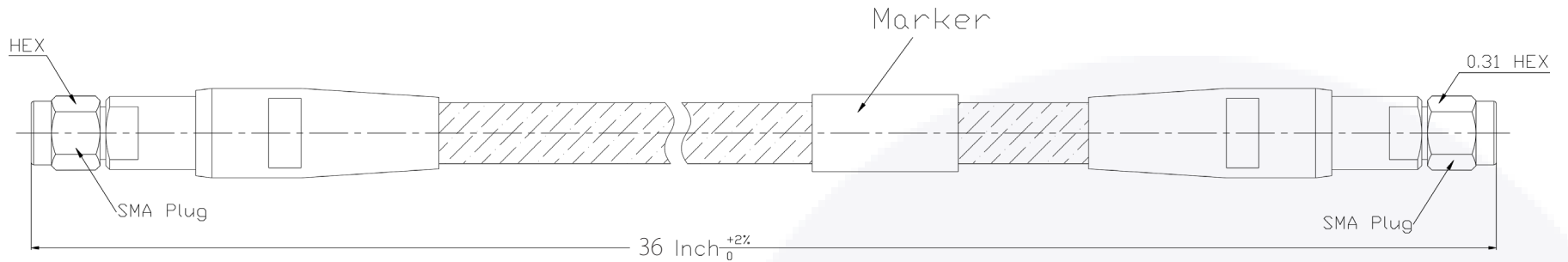

LTR	DESCRIPTION	DATE	APPR.	DRAWN BY: JMS	CHECKED BY: TAC		5214 Bonsai Street • Moorpark, CA 93021 (888) 498-3242 • sales@hasco-inc.com www.hasco-inc.com			
-	RELEASE	08/19	TAC	APPROVED BY: TAC						
A	JACKET COLOR CHANGE	10/20	TAC	THESE DRAWINGS AND SPECIFICATIONS ARE THE PROPERTY OF HASCO COMPONENTS AND SHALL NOT BE REPRODUCED, COPIED NOR USED - IN WHOLE OR IN PART - AS THE BASIS FOR THE MANUFACTURE OR SALE OF OTHER ITEMS WITHOUT THE EXPRESS, WRITTEN PERMISSION OF HASCO COMPONENTS.			MATERIALS:	CAGE CODE:	SCALE:	SIZE:
							SEE DATA SHEET	0T8L4	NS	-
							FINISHES:	PART NO./DRAWING NO.		REV:
							SEE DATA SHEET	HLL283R-S1-S1-36		-
THIS DRAWING IS A CONTROLLED DOCUMENT										