

THIS DRAWING UNPUBLISHED.

RELEASED FOR PUBLICATION

LOC		DIST		REVISIONS			DATE	DWN	APVD
P	LTR								
-	-	-	-	-	-	-	-	-	

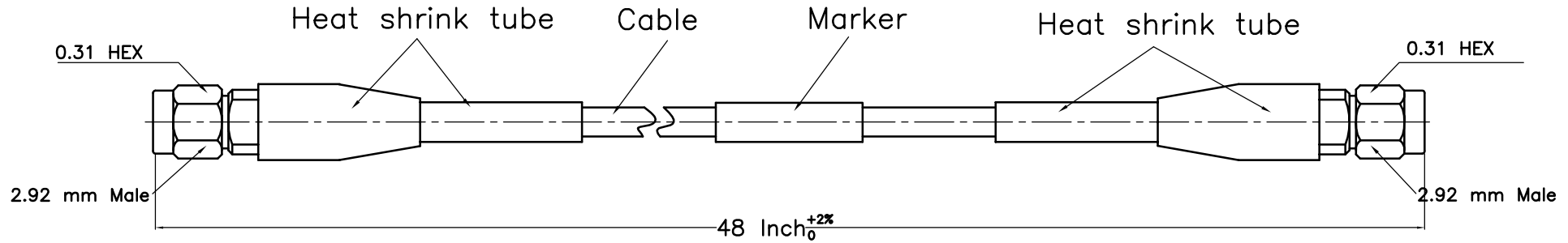

NOTES:

1.ELECTRICAL:

- 1.1 IMPEDANCE: 50Ω
- 1.2 INSULATION RESISTANCE: 5000MΩ MIN
- 1.3 FREQUENCY RANGE: DC~40GHz
- 1.4 DIELECTRIC WITHSTANDING VOLTAGE: 1000V MAX AT SEA LEVEL
- 1.5 VSWR ≤ 1.35:1 @ DC-40GHz
- 1.6 INSERTION LOSS: ≤ 4.0dB @ 40GHz

2.ENVIRONMENTAL:

TEMPERATURE RANGE: -55° to +85°

3. CONNECTOR MATERIAL AND FINISH:

BODY: STAINLESS STEEL TYPE 303, PASSIVATE
 NUT: STAINLESS STEEL TYPE 303, PASSIVATE
 CENTER CONTACT: BERYLLIUM COPPER
 , GOLD PLATING
 DIELECTRIC: PEEK, N/A

THIS DRAWING IS A CONTROLLED DOCUMENT.		DWN	DWP	15/08/2012	HASCO		
		CHK			HyTech Associates Sales Company, Inc		
DIMENSIONS INCHES		TOLERANCES UNLESS OTHERWISE SPECIFIED:		NAME HULL140® Series			
		0 PLC	±0.25		PRODUCT SPEC		
		1 PLC	±0.15		40GHz Ultra Low Loss Flexible Cable Assemblies		
		2 PLC	±0.12		Excellent Phase Stability		
		3 PLC	±		vs. Flexure & Temperature		
		4 PLC	±		SIZE	CAGE CODE	DRAWING NO
		ANGLES	±1°		A3	OT8L4	HULL140-29P-29P-48
MATERIAL SEE TABLE		FINISH SEE TABLE		WEIGHT		CUSTOMER DRAWING	
				SCALE	4: 1	SHEET	1 OF 1 RVE 1