

Part No:

# HWEB06-1-1-ER



## *WR-6 Millimeter Waveguide E-Bend Section, 1 Inch 110 GHz to 175 GHz, D-Band*

### Specifications

- Frequency Range 110 GHz to 175 GHz
- VSWR 1.03:1
- Impedance 50 Ohms
- Length 1 inch
- RF Ports WR-6 Waveguide with UG-387/U-M Flange

### Environmental Data

- Temperature Range 220°C Max

### Material

- Waveguide OFHC Copper
- Flange Round UG-387/U-M, Brass
- Finish Gold Plated per MIL-DTL-45204

The HASCO WR-6 Millimeter Waveguide E-Bend Section **HWEB06-1-1-ER** operates from 110 GHz to 175 GHz. This WR-6, D-Band waveguide section is constructed with a Round UG-387/U-M Flange.

HASCO rectangular waveguides are manufactured from brass, OFHC copper, aluminum or coin silver. Waveguides have significant advantages over coaxial transmission in power handling, insertion loss and signal integrity (leakage and electromagnetic interference - EMI).

HASCO offers a series of millimeter waveguide straight sections, E-Bends, H-Bends and 90° Twists. Anti-cocking flanges available if required. All are available in standard and custom lengths covering the waveguide sizes WR-3, WR-4, WR-5, WR-6, WR-8, WR-10, WR-12, WR-15, WR-19, WR-22, WR-28, WR-34 and WR-42. Square waveguide flanges are available in WR-22, WR-28, WR-34 and WR-42. Please contact HASCO for custom options.

To view online, go to: <https://www.hasco-inc.com/waveguide-components/wr-6-millimeter-waveguide-e-bend-1-inch-section-110-ghz-to-175-ghz-d-band/>

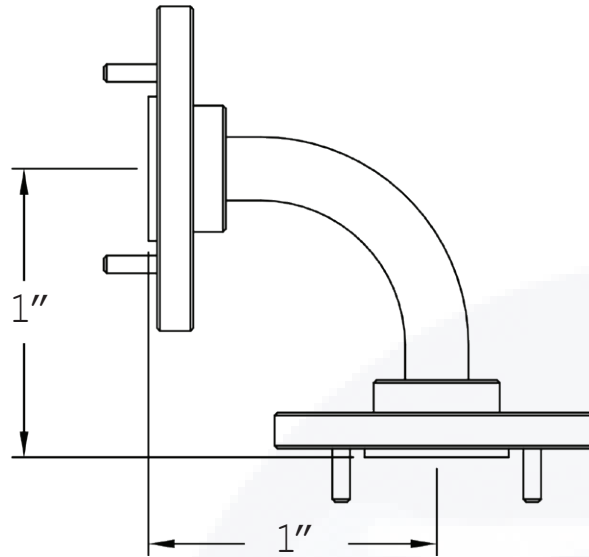
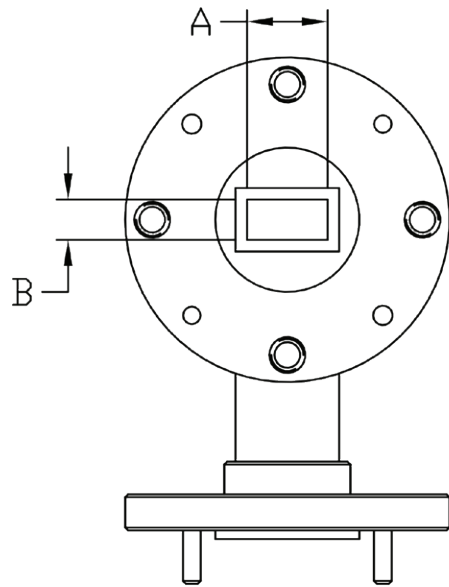

Part Number	WG Size	DIM A	DIM B
HWEB22-X-X-ER	WR-22	0.224	0.112
HWEB19-X-X-ER	WR-19	0.188	0.094
HWEB15-X-X-ER	WR-15	0.148	0.074
HWEB12-X-X-ER	WR-12	0.122	0.061
HWEB10-X-X-ER	WR-10	0.100	0.050
HWEB08-X-X-ER	WR-08	0.080	0.040
HWEB06-X-X-ER	WR-06	0.065	0.0325
HWEB05-X-X-ER	WR-05	0.051	0.0255
HWEB04-X-X-ER	WR-04	0.043	0.0215
HWEB03-X-X-ER	WR-03	0.034	0.017

To view online, go to: <https://www.hasco-inc.com/waveguide-components/wr-6-millimeter-waveguide-e-bend-1-inch-section-110-ghz-to-175-ghz-d-band/>

LTR	DESCRIPTION	DATE	APPR.	CREATED BY: JMS	CHECKED BY: TAC		5214 Bonsai Street • Moorpark, CA 93021 (888) 498-3242 • sales@hasco-inc.com <a href="http://www.hasco-inc.com">www.hasco-inc.com</a>			
-	RELEASE	11/19	TAC	APPROVED BY: TAC						
				THESE DRAWINGS AND SPECIFICATIONS ARE THE PROPERTY OF HASCO COMPONENTS AND SHALL NOT BE REPRODUCED, COPIED NOR USED - IN WHOLE OR IN PART - AS THE BASIS FOR THE MANUFACTURE OR SALE OF OTHER ITEMS WITHOUT THE EXPRESS, WRITTEN PERMISSION OF HASCO COMPONENTS.			MATERIALS:	CAGE CODE:	SCALE:	SIZE:
							SEE DATA SHEET	0T8L4	N/A	A
							FINISHES:	PART NO./DRAWING NO.		REV:
							SEE DATA SHEET	<b>HWEB06-1-1-ER</b>		-
THIS DRAWING IS A CONTROLLED DOCUMENT										