

Part No:

HWEB08-1-1-ER



WR-8 Millimeter Waveguide E-Bend Section, 1 Inch 90 GHz to 140 GHz, F-Band

Specifications

• Frequency Range	90 GHz to 140 GHz
• VSWR	1.03:1
• Impedance	50 Ohms
• Length	1 inch
• RF Ports	WR-8 Waveguide with UG-387/U-M Flange

Environmental Data

• Temperature Range	220°C Max
---------------------	-----------

Material

• Waveguide	OFHC Copper
• Flange	Round UG-387/U-M, Brass
• Finish	Gold Plated per MIL-DTL-45204

The HASCO WR-8 Millimeter Waveguide E-Bend Section **HWEB08-1-1-ER** operates from 90 GHz to 140 GHz. This WR-8, F-Band waveguide section is constructed with a Round UG-387/U-M Flange.

HASCO rectangular waveguides are manufactured from brass, OFHC copper, aluminum or coin silver. Waveguides have significant advantages over coaxial transmission in power handling, insertion loss and signal integrity (leakage and electromagnetic interference - EMI).

HASCO offers a series of millimeter waveguide straight sections, E-Bends, H-Bends and 90° Twists. Anti-cocking flanges available if required. All are available in standard and custom lengths covering the waveguide sizes WR-3, WR-4, WR-5, WR-6, WR-8, WR-10, WR-12, WR-15, WR-19, WR-22, WR-28, WR-34 and WR-42. Square waveguide flanges are available in WR-22, WR-28, WR-34 and WR-42. Please contact HASCO for custom options.

To view online, go to: <https://www.hasco-inc.com/waveguide-components/wr-8-millimeter-waveguide-e-bend-1-inch-section-90-ghz-to-140-ghz-f-band/>

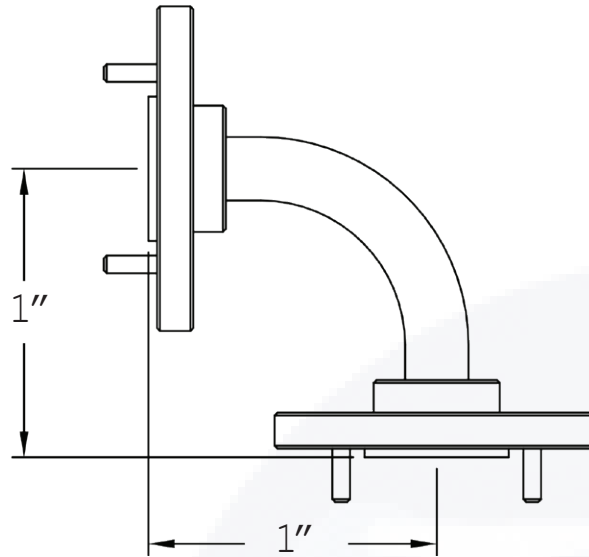
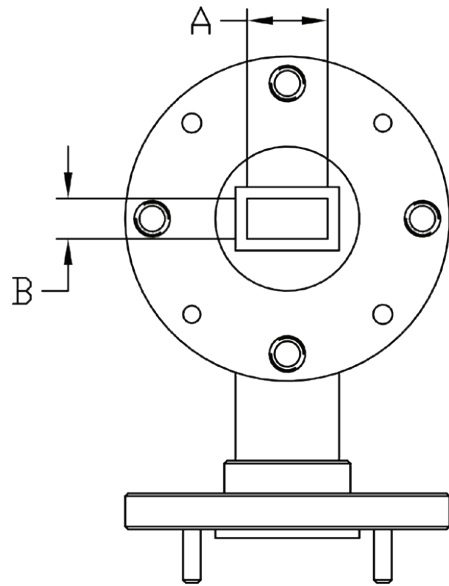

Part Number	WG Size	DIM A	DIM B
HWEB22-X-X-ER	WR-22	0.224	0.112
HWEB19-X-X-ER	WR-19	0.188	0.094
HWEB15-X-X-ER	WR-15	0.148	0.074
HWEB12-X-X-ER	WR-12	0.122	0.061
HWEB10-X-X-ER	WR-10	0.100	0.050
HWEB08-X-X-ER	WR-08	0.080	0.040
HWEB06-X-X-ER	WR-06	0.065	0.0325
HWEB05-X-X-ER	WR-05	0.051	0.0255
HWEB04-X-X-ER	WR-04	0.043	0.0215
HWEB03-X-X-ER	WR-03	0.034	0.017

To view online, go to: <https://www.hasco-inc.com/waveguide-components/wr-8-millimeter-waveguide-e-bend-1-inch-section-90-ghz-to-140-ghz-f-band/>

LTR	DESCRIPTION	DATE	APPR.	CREATED BY: JMS	CHECKED BY: TAC
-	RELEASE	11/19	TAC	APPROVED BY: TAC	
				THESE DRAWINGS AND SPECIFICATIONS ARE THE PROPERTY OF HASCO COMPONENTS AND SHALL NOT BE REPRODUCED, COPIED NOR USED - IN WHOLE OR IN PART - AS THE BASIS FOR THE MANUFACTURE OR SALE OF OTHER ITEMS WITHOUT THE EXPRESS, WRITTEN PERMISSION OF HASCO COMPONENTS.	
THIS DRAWING IS A CONTROLLED DOCUMENT					



5214 Bonsai Street • Moorpark, CA 93021
 (888) 498-3242 • sales@hasco-inc.com
www.hasco-inc.com

MATERIALS: SEE DATA SHEET	CAGE CODE: 0T8L4	SCALE: N/A	SIZE: A
FINISHES: SEE DATA SHEET	PART NO./DRAWING NO. HWEB08-1-1-ER		REV: -