

Part No:

HWHB15-2-2-ER

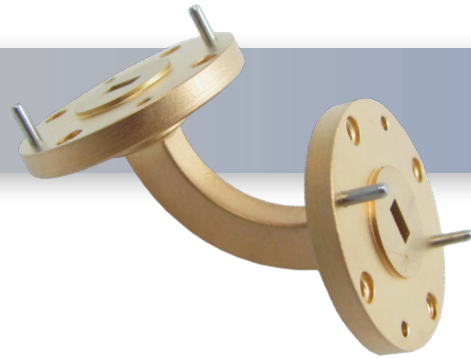

WR-15 Millimeter Waveguide H-Bend Section, 2 Inch 50 GHz to 75 GHz, V-Band

The HASCO WR-15 Millimeter Waveguide H-Bend Section **HWHB15-2-2-ER** operates from 50 GHz to 75 GHz. This WR-15, V-Band waveguide section is constructed with a Round UG-385/U Flange.

HASCO rectangular waveguides are manufactured from brass, OFHC copper, aluminum or coin silver. Waveguides have significant advantages over coaxial transmission in power handling, insertion loss and signal integrity (leakage and electromagnetic interference - EMI).

HASCO offers a series of millimeter waveguide straight sections, H-Bends, H-Bends and 90° Twists. Anti-cocking flanges available if required. All are available in standard and custom lengths covering the waveguide sizes WR-3, WR-4, WR-5, WR-6, WR-8, WR-10, WR-12, WR-15, WR-19, WR-22, WR-28, WR-34 and WR-42. Square waveguide flanges are available in WR-22, WR-28, WR-34 and WR-42. Please contact HASCO for custom options.

Specifications

- Frequency Range 50 GHz to 75 GHz
- VSWR 1.03:1
- Impedance 50 Ohms
- Length 2 inch
- RF Ports WR-15 Waveguide with UG-385/U Flange

Environmental Data

- Temperature Range 220°C Max

Material

- Waveguide OFHC Copper
- Flange Round UG-385/U, Brass
- Finish Gold Plated per MIL-DTL-45204

To view online, go to: <https://www.hasco-inc.com/waveguide-components/wr-15-millimeter-waveguide-h-bend-2-inch-section-50-ghz-to-75-ghz-v-band/>

HWHB15-2-2-ER | 50 GHz to 75 GHz | Outline Drawing

Part Number	WG Size	DIM A	DIM B
HWHB22-X-X-ER	WR-22	0.224	0.112
HWHB19-X-X-ER	WR-19	0.188	0.094
HWHB15-X-X-ER	WR-15	0.148	0.074
HWHB12-X-X-ER	WR-12	0.122	0.061
HWHB10-X-X-ER	WR-10	0.100	0.050
HWHB08-X-X-ER	WR-08	0.080	0.040
HWHB06-X-X-ER	WR-06	0.065	0.0325
HWHB05-X-X-ER	WR-05	0.051	0.0255
HWHB04-X-X-ER	WR-04	0.043	0.0215
HWHB03-X-X-ER	WR-03	0.034	0.017

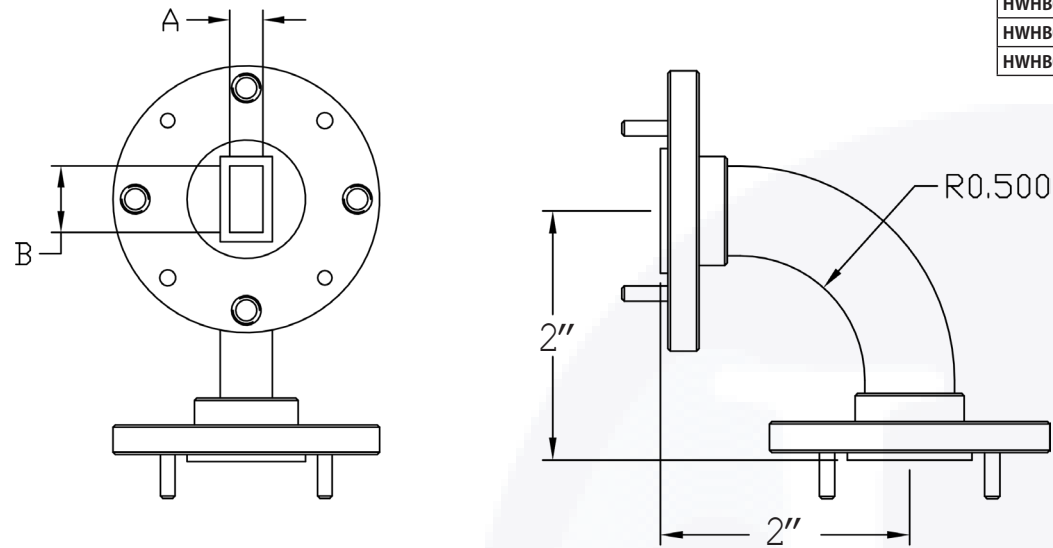

To view online, go to: <https://www.hasco-inc.com/waveguide-components/wr-15-millimeter-waveguide-h-bend-2-inch-section-50-ghz-to-75-ghz-v-band/>

LTR	DESCRIPTION	DATE	APPR.	CREATED BY: <i>JMS</i>	CHECKED BY: <i>TAC</i>		5214 Bonsai Street • Moorpark, CA 93021 (888) 498-3242 • sales@hasco-inc.com www.hasco-inc.com			
-	RELEASE	11/19	TAC	APPROVED BY: <i>TAC</i>						
				THESE DRAWINGS AND SPECIFICATIONS ARE THE PROPERTY OF HASCO COMPONENTS AND SHALL NOT BE REPRODUCED, COPIED NOR USED - IN WHOLE OR IN PART - AS THE BASIS FOR THE MANUFACTURE OR SALE OF OTHER ITEMS WITHOUT THE EXPRESS, WRITTEN PERMISSION OF HASCO COMPONENTS.			MATERIALS:	CAGE CODE:	SCALE:	SIZE:
							SEE DATA SHEET	0T8L4	N/A	A
							FINISHES:	PART NO./DRAWING NO.		REV:
							SEE DATA SHEET	HWHB15-2-2-ER		-
THIS DRAWING IS A CONTROLLED DOCUMENT										